

100% DOWN

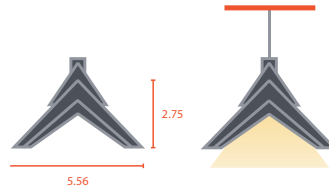

UP TO 119 lm/W PERFORMANCE				
DELIVERED LUMENS (SYSTEM)	3,050	2,450	2,050	1,600
LUMENS PER FT.	0% UP	-	-	-
	100% DOWN	763	613	513
SYSTEM WATTS	25	21	18	14
EFFICACY (lm/W)	126	118	117	116
CALCULATED L80 (h)	80,000			

Performance based on 4-foot luminaire at 4,000K @ 25-degrees C

LIGHT LOSS FACTOR		
CCT	CRI	%
4000K	84+	100%
3500K	84+	97.1%
3000K	84+	95.7%
2700K	84+	94.1%
4000K	92+	88.9%
3500K	92+	85.5%
3000K	92+	83.8%
2700K	92+	82.4%

STANDARD FINISHES
Black, White, & Silver

ORDER GUIDE

AX.5 -P-D	100													
A	B	C	D	E	F	G	H	I	J	K	L	M		

EXAMPLE
AX.5-P-D | 100 | C | 6 | 27K | 9 | UNV | S1 | W | W | ST | 9C | 42 | EB, WF, WC

OPTIONS

N (Multiple Selections)



A. MODEL	B. DISTRIBUTION	C. OUTPUT	D. LENGTH	E. COLOR TEMPERATURE
AX.5 -P-D	100 100% Direct	A 763 lm/ft B 613 lm/ft C 513 lm/ft D 400 lm/ft	4 4 ft (48 in) 6 6 ft (72 in) 8 8 ft (96 in) XXX System Run PATxSH Pattern	27K 2700K 30K 3000K 35K 3500K 40K 4000K

F. CRI	G. VOLTAGE	H. DRIVER	I. HOUSING FINISH	J. END CAP FINISH
8 80+CRI 9 90+CRI	UNV 120-277v 347 347v	S1 1% Dimming (0-10v) LDE1 Lutron Hi-Lume 1% LDE5 Lutron 5 Series ELO 0.1% EldoLED DXL 1% Dexal	W White B Black S Silver CC Custom Colors	W White B Black S Silver LC LUX Orange CC Custom Color

90 CRI option has an R9 value greater than 60.	347 may not be available in all configurations.		2 ft and 3 ft available only with Spoke Center Hub option. Please see Pattern Guide on p.2 for further details SPK 2x2x2 B W X Y	See page 3 for more information on finishes. Consult factory for custom colors.	See page 3 for more information on finishes. Consult factory for custom colors.
--	---	--	--	--	--

K. DRIVER HOUSING		L. MOUNTING TYPE		M. SUSPENSION LENGTH		N. FACTORY OPTIONS	
ST Structure R Remote	9C 9/16 in. Tee Clip 15C 5/16 in. Tee Clip SC Screw Slot Tee Clip HC Hard/Opening Ceiling	24 24 in 42 42 in 102 102 in 150 150 in	EB Emergency Battery (10-Watt) WF White Power Feed WC White Canopy	BF Black Power Feed BC Black Canopy SF Silver Power Feed SC Silver Canopy Feed			

Structure - Only available for individual luminaire lengths. Roomside or exposed ceilings.

May choose more than one option in this category.

LIGHT SOURCE

Long life name brand LED chips and boards to ensure the highest of quality while providing even and smooth illumination throughout our luminaires.

Our luminaires are available in 2700K, 3000K, 3500K and 4000K color temperature .

Optional 80CRI or 90CRI available in all CCT options.

LUMEN MAINTENANCE

The projected lumen maintenance of the name brand mid-powered LED's are projected to maintain 80% (L80) of their initial output for +80,000 hours.

CONSTRUCTION

The housings are constructed of (6063T5) extruded aluminum. Our internal joiner system is designed to the highest of standards to ensure our precision cut housings align and fit tightly without light leak. Our precision fitting end caps are constructed out of die cast aluminum.

FINISH

Polyester powder, low gloss textured paint finish applied after a multi-stage pretreatment. Standard luminaire finishes include white, silver, and black. Custom color options are available. (Consult Factory).

OPTICS

Anidolic Light Guide technology.

DRIVERS

All of our luminaires come standard with 1% dimming and THD <20% utilizing 0-10v constant current protocol. 120v/277v is standard with the option of 347v.

EMERGENCY

An integral factory installed 10 watt emergency battery pack. Emergency circuit and Night Light circuit options are available.

LUMINAIRE LENGTH

Our AX.5 Pendant Direct luminaire series are available in 4', 6', and 8' individual lengths or continuous row configurations. Continuous row configurations are joined together on-site utilizing the joiner kits provided.

LUMINAIRE WEIGHT

The approximate weight of a four foot luminaire is 16.8 lbs including end caps assembled.

PATTERN GUIDE

W. PATTERN CODE	X. DIMENSIONS OF PATTERN	Y. SPOKE CENTER HUB COLOR
Spoke Center Hub - Pattern SPK	Enter length of each segment in pattern separated by an "x" <i>Available choices in lengths of 2, 3, 4, 6 and 8 ft.</i>	AxBxC Black B White W Silver S Custom Colors CC

NOTES

- Spoke Center Hub is non-illuminated.
- Arms are available in lengths of 2, 3, 4, 6 and 8 ft.
- Patterns in all cases will require a signed-off submittal prior to release of an order.
- Dimensions for Patterns are based on outside dimensions of the pattern.
- As a standard, the color of the Spoke Center Hub will match the selected housing color; unless otherwise specified.

PAT X H

PAT = Pattern
 AxBxC = Length of each segment in Pattern separated by an "x"
 @ = Pattern Code (See reference examples)
 H = Pattern Orientation

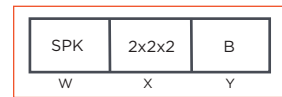

Above code gets entered in "D" LENGTH field of ordering guide.

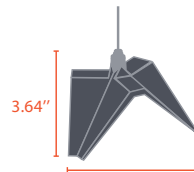
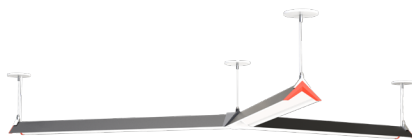
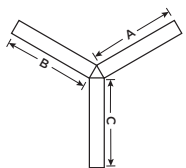

SPOKE CENTER HUB - SIDE VIEW

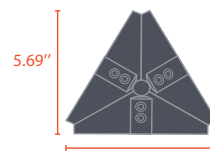

SPOKE CENTER HUB - OVERHEAD



STANDARD FINISHES

The AX.5 enhances the aesthetic of any space through flexible color combinations. Choose a white, black or silver housing with 1 of 4 standard end cap colors. Custom colors are also available upon request.



WHITE
Shown with White Housing, White End Cap and Silver Cleat



SILVER
Shown with Silver Housing, Silver End Cap and Silver Cleat

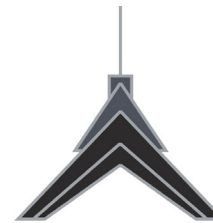
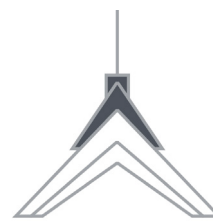

END CAP COLORS



BLACK
Shown with Black Housing, Black End Cap and Silver Cleat



DRIVER HOUSING MOUNTING OPTIONS

REMOTE HOUSING

Grid-mountable driver housing with integrated T-Wing mounts.

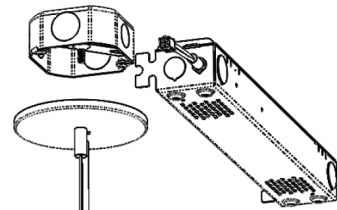
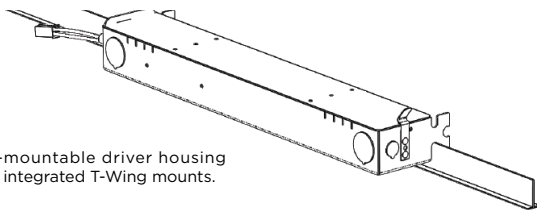

Remote-mounted driver housing with integrated mounting features, including power feed, canopy, and suspension system. Suitable for exposed conduit, or recessed junction boxes.

STRUCTURE HOUSING

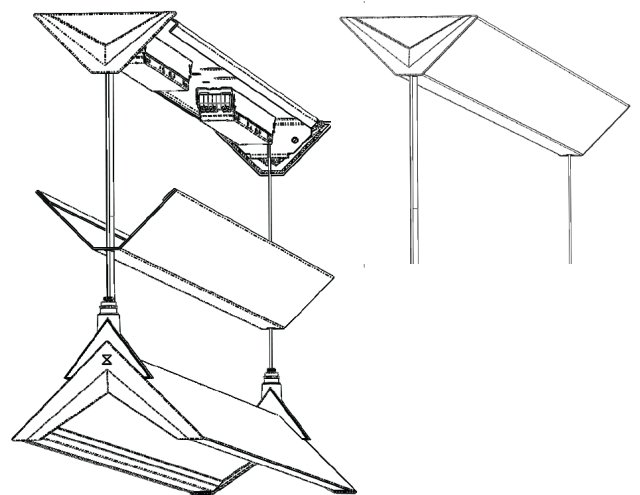

Room side surface-mounted driver housing with integrated suspension mounts. Suitable for solid surface, exposed surface, and grid ceiling.



CONTINUOUS RUN ORDER GUIDES

Please use the following run guides for fixture ordering. If your product will require a submittal, our in-house Application Engineering Team will work closely with you on your project.

ALUMINUM PRODUCT ORDER GUIDE	
RUN LENGTH (ft)	RUN CONFIGURATION - SECTION LENGTHS
10	6' + 4'
12	6' + 6'
14	8' + 6'
16	8' + 8'
18	6' + 6' + 6'
20	8' + 4' + 8'
22	8' + 6' + 8'
24	8' + 8' + 8'
26	4' + 6' + 6' + 6' + 4'
28	6' + 8' + 8' + 6'
30	6' + 6' + 6' + 6' + 6'
32	8' + 8' + 8' + 8'
34	6' + 8' + 8' + 8' + 4'
36	6' + 8' + 8' + 8' + 6'
38	8' + 8' + 6' + 8' + 8'
40	8' + 8' + 6' + 8' + 8'
42	6' + 8' + 8' + 8' + 8' + 4'
44	6' + 8' + 8' + 8' + 8' + 6'
46	3' + 8' + 8' + 8' + 8' + 8' + 3'
48	8' + 8' + 8' + 8' + 8' + 8'
50	6' + 8' + 8' + 8' + 8' + 8' + 4'

*Standard Run Configurations Shown, Consult Factory for Custom Configurations.

