

SEE PERFORMANCE CHART ON PAGE 2

STANDARD FINISHES
Black, White, & Silver

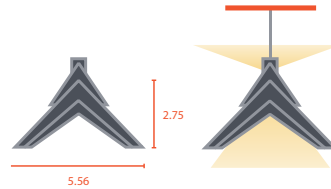

LIGHT LOSS FACTOR		
CCT	CRI	%
4000K	84+	100%
3500K	84+	97.1%
3000K	84+	95.7%
2700K	84+	94.1%
4000K	92+	88.9%
3500K	92+	85.5%
3000K	92+	83.8%
2700K	92+	82.4%

LUX | **ENABLED**

Suitable for Damp Locations

UL CERTIFIED SAFETY US-CA

5 YEAR WARRANTY

MADE IN U.S.A.

ORDER GUIDE

AX.5 - P - DI																		
A	B	C	D	E	F	G	H	I	J	K	L	M	N	N (Multiple Selections)				

EXAMPLE: AXS-P-DI | 70/30 | C | 6 | 27K | 9 | UNV | S1 | W | W | ST | 9C | 42 | WF,WC | EB

OPTIONS

A. MODEL	B. DISTRIBUTION		C. OUTPUT		D. LENGTH		E. COLOR TEMPERATURE	
AX.5 - P - DI	30/70	30% Direct, 70% Indirect	A	1150 lm/ft	4	4 ft (48 in)	27K	2700K
	40/60	40% Direct, 60% Indirect	B	1038 lm/ft	6	6 ft (72 in)	30K	3000K
	50/50	50% Direct, 50% Indirect	C	900 lm/ft	8	8 ft (96 in)	35K	3500K
	60/40	60% Direct, 40% Indirect	D	763 lm/ft	XXX	System Run	40K	4000K
	70/30	70% Direct, 30% Indirect			SPK	Spoke Pattern		

NOTES

						Please see Pattern Guide on p.2 for further details. More length options available for Spoke Pattern.									
						<table border="1"> <tr> <td>SPK</td> <td>2x2x2</td> <td>B</td> </tr> <tr> <td>W</td> <td>X</td> <td>Y</td> </tr> </table>		SPK	2x2x2	B	W	X	Y		
SPK	2x2x2	B													
W	X	Y													
F. CRI	G. VOLTAGE	H. DRIVER		I. HOUSING FINISH		J. END CAP FINISH									
8	UNV 120-277v	S1	1% Dimming (0-10v)	W	White	W	White								
9	347 347v	LDE1	Lutron Hi-Lume 1%	B	Black	B	Black								
		ELO	0.1% EldoLED	S	Silver	S	Silver								
		DXL	1% Dexal	CC	Custom Colors	LC	LUX Orange								
						CC	Custom Color								
90 CRI option has an R9 value greater than 60.		347 may not be available in all configurations.		See page 3 for more information on finishes.		See page 3 for more information on finishes.									
				Consult factory for custom colors. (Power feeds and canopies excluded)		Consult factory for custom colors.									

OPTIONS

K. DRIVER HOUSING	L. MOUNTING TYPE	M. SUSPENSION LENGTH	N. POWER FEEDS & CANOPIES	O. CONTROLS & FACTORY OPTIONS
ST Structure	9C 9/16 in. Tee Clip	24 24 in	WF White Power Feed	AWNR-W Lutron Athena Wireless Node (RF-only) in White
R Remote	15C 15/16 in. Tee Clip	42 42 in	BF Black Power Feed	AWNR-B Lutron Athena Wireless Node (RF-only) in Black
	SC Screw Slot Tee Clip	102 102 in	SF Silver Power Feed	EB Lutron Athena Emergency Battery (10-Watt)
	HC Hard/Opening Ceiling	150 150 in	WC White Canopy	
			BC Black Canopy	
			SC Silver Canopy	

Structure - Only available for individual luminaire lengths. Roomside or exposed ceilings.	Each individual suspension length is adjustable.	Select feed and canopy choice.	May choose more than one option in this category.
--	--	--------------------------------	---

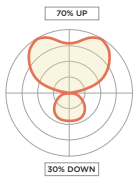

UP TO 119 lm/W PERFORMANCE					
DELIVERED LUMENS (SYSTEM)		4,600	4,150	3,600	3,050
LUMENS PER FT.	70% UP	805	726	630	534
	30% DOWN	345	311	270	229
WATTS PER FOOT		9.75	8.75	7.75	6.75
EFFICACY (lm/W)		119	118	117	116
CALCULATED L80 (h)		80,000			
Performance based on 4-foot luminaire at 4,000K @ 25-degrees C					

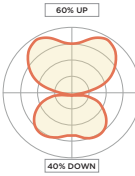

UP TO 119 lm/W PERFORMANCE					
DELIVERED LUMENS (SYSTEM)		4,600	4,150	3,600	3,050
LUMENS PER FT.	60% UP	690	623	540	458
	40% DOWN	460	415	360	305
WATTS PER FOOT		9.75	8.75	7.75	6.75
EFFICACY (lm/W)		120	120	119	117
CALCULATED L80 (h)		80,000			
Performance based on 4-foot luminaire at 4,000K @ 25-degrees C					

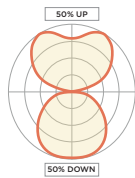

UP TO 119 lm/W PERFORMANCE					
DELIVERED LUMENS (SYSTEM)		4,600	4,150	3,600	3,050
LUMENS PER FT.	50% UP	575	519	450	381
	50% DOWN	575	519	450	381
WATTS PER FOOT		9.75	8.75	7.75	6.75
EFFICACY (lm/W)		121	121	119	117
CALCULATED L80 (h)		80,000			
Performance based on 4-foot luminaire at 4,000K @ 25-degrees C					

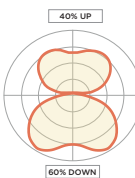

UP TO 119 lm/W PERFORMANCE					
DELIVERED LUMENS (SYSTEM)		4,600	4,150	3,600	3,050
LUMENS PER FT.	40% UP	460	415	360	305
	60% DOWN	690	623	540	458
WATTS PER FOOT		9.75	8.75	7.75	6.75
EFFICACY (lm/W)		121	121	120	118
CALCULATED L80 (h)		80,000			
Performance based on 4-foot luminaire at 4,000K @ 25-degrees C					

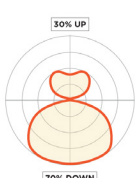

UP TO 119 lm/W PERFORMANCE					
DELIVERED LUMENS (SYSTEM)		4,600	4,150	3,600	3,050
LUMENS PER FT.	30% UP	345	311	270	229
	70% DOWN	805	726	630	534
WATTS PER FOOT		9.75	8.75	7.75	6.75
EFFICACY (lm/W)		121	118	119	116
CALCULATED L80 (h)		80,000			
Performance based on 4-foot luminaire at 4,000K @ 25-degrees C					

LIGHT SOURCE

Long life name brand LED chips and boards to ensure the highest of quality while providing even and smooth illumination throughout our luminaires.

Our luminaires are available in 2700K, 3000K, 3500K and 4000K color temperature .

Optional 80CRI or 90CRI available in all CCT options.

LUMEN MAINTENANCE

The projected lumen maintenance of the name brand mid-powered LED's are projected to maintain 80% (L80) of their initial output for +80,000 hours.

CONSTRUCTION

The housings are constructed of (6063T5) extruded aluminum. Our internal joiner system is designed to the highest of standards to ensure our precision cut housings align and fit tightly without light leak. Our precision fitting end caps are constructed out of die cast aluminum.

FINISH

Polyester powder, low gloss textured paint finish applied after a multi-stage pretreatment. Standard luminaire finishes include white, silver, and black. Custom color options are available. (Consult Factory).

OPTICS

Andolic Light Guide Technology; Direct & Indirect Batwing Distribution.

DRIVERS

All of our luminaires come standard with 1% dimming and THD <20% utilizing 0-10v constant current protocol. 120v/277v is standard with the option of 347v.

EMERGENCY

An integral factory installed 10 watt emergency battery pack contained in remote driver enclosure. Emergency circuit and Night Light circuit capable by connecting to appropriate circuit in the field.

LUMINAIRE LENGTH

Our AX.5 Pendant Direct Indirect luminaire series are available in 4', 6', and 8' individual lengths or continuous row configurations. Continuous row configurations are joined together on-site utilizing the joiner kits provided.

LUMINAIRE WEIGHT

The approximate weight of a four foot luminaire is 16.8 lbs Including end caps assembled.

PATTERN GUIDE

W. PATTERN CODE	X. X. PATTERN DIMENSIONS	Y. SPOKE CENTER HUB COLOR
Spoke Center Hub - Pattern SPK	Enter length of each segment in pattern separated by an "x" Available choices in lengths of 2, 3, 4, 6 and 8 ft. AxBxC	Black White Silver Custom Colors B W S CC

NOTES

Spoke Center Hub is non-illuminated.

Patterns in all cases will require a signed-off submittal prior to release of an order.

Dimensions for Patterns are based on outside dimensions of the pattern.

As a standard, the color of the Spoke Center Hub will match the selected housing color; unless otherwise specified.

PAT X H

PAT = Pattern
A x B x C = Length of each segment in Pattern separated by an "x"
@ = Pattern Code (See reference examples)
H = Pattern Orientation

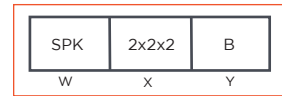

Above code gets entered in "D" LENGTH field of ordering guide.

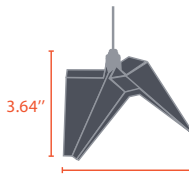
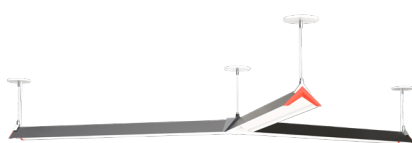
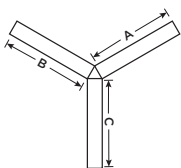

SPOKE CENTER HUB - SIDE VIEW

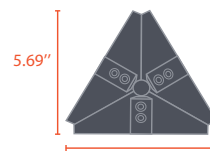

SPOKE CENTER HUB - OVERHEAD

STANDARD FINISHES

The AX.5 enhances the aesthetic of any space through flexible color combinations. Choose a white, black or silver housing with 1 of 4 standard end cap colors. Custom colors are also available upon request.



WHITE
Shown with White Housing, White End Cap and Silver Cleat



SILVER
Shown with Silver Housing, Silver End Cap and Silver Cleat

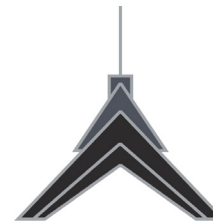
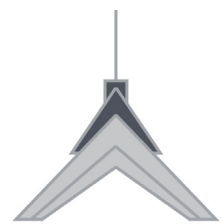
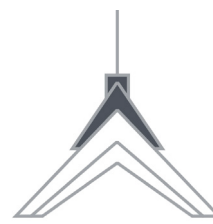

END CAP COLORS



BLACK
Shown with Black Housing, Black End Cap and Silver Cleat



ORANGE
Shown with Black Housing, Orange End Cap and Silver Cleat

DRIVER HOUSING MOUNTING OPTIONS

REMOTE HOUSING

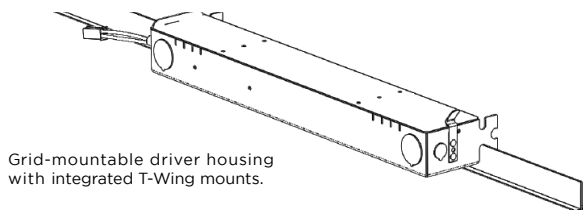

Grid-mountable driver housing with integrated T-Wing mounts.

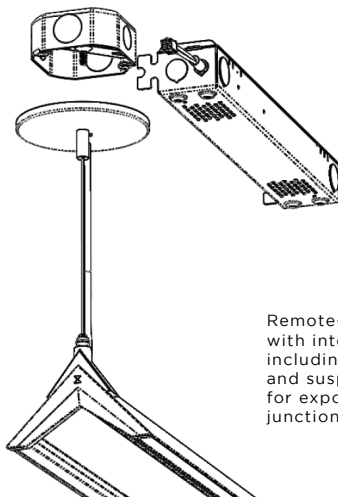

Remote-mounted driver housing with integrated mounting features, including power feed, canopy, and suspension system. Suitable for exposed conduit, or recessed junction boxes.

STRUCTURE HOUSING

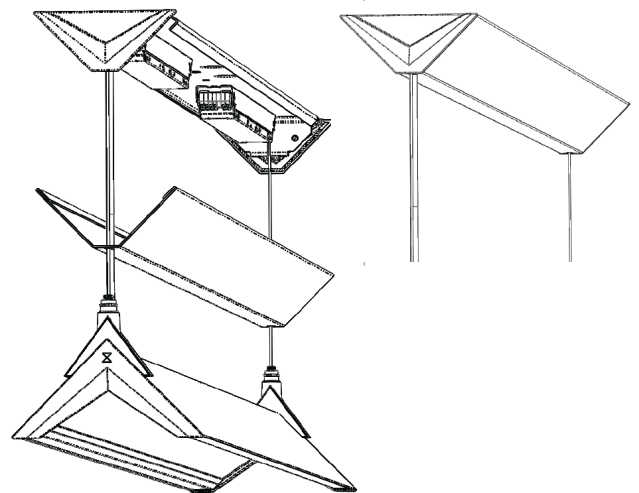

Room side surface-mounted driver housing with integrated suspension mounts. Suitable for solid surface, exposed surface, and grid ceiling.



CONTINUOUS RUN ORDER GUIDES

Please use the following run guides for fixture ordering. If your product will require a submittal, our in-house Application Engineering Team will work closely with you on your project.

ALUMINUM PRODUCT ORDER GUIDE	
RUN LENGTH (ft)	RUN CONFIGURATION - SECTION LENGTHS
10	6' + 4'
12	6' + 6'
14	8' + 6'
16	8' + 8'
18	6' + 6' + 6'
20	8' + 4' + 8'
22	8' + 6' + 8'
24	8' + 8' + 8'
26	4' + 6' + 6' + 6' + 4'
28	6' + 8' + 8' + 6'
30	6' + 6' + 6' + 6' + 6'
32	8' + 8' + 8' + 8'
34	6' + 8' + 8' + 8' + 4'
36	6' + 8' + 8' + 8' + 6'
38	8' + 8' + 6' + 8' + 8'
40	8' + 8' + 8' + 8' + 8'
42	6' + 8' + 8' + 8' + 8' + 4'
44	6' + 8' + 8' + 8' + 8' + 6'
46	4' + 8' + 8' + 6' + 8' + 8' + 4'
48	8' + 8' + 8' + 8' + 8' + 8'
50	6' + 8' + 8' + 8' + 8' + 8' + 4'

*Standard Run Configurations Shown, Consult Factory for Custom Configurations.

